

R2 +3 Balsa

3mm

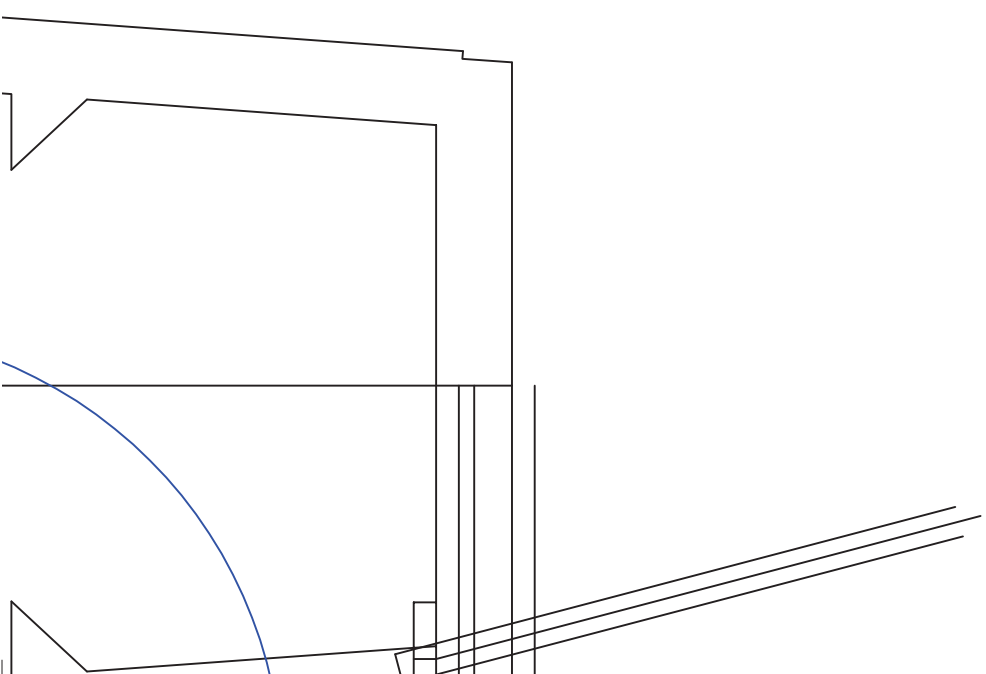

3n

Biegelinie

Bowdenzugrohr

3mm

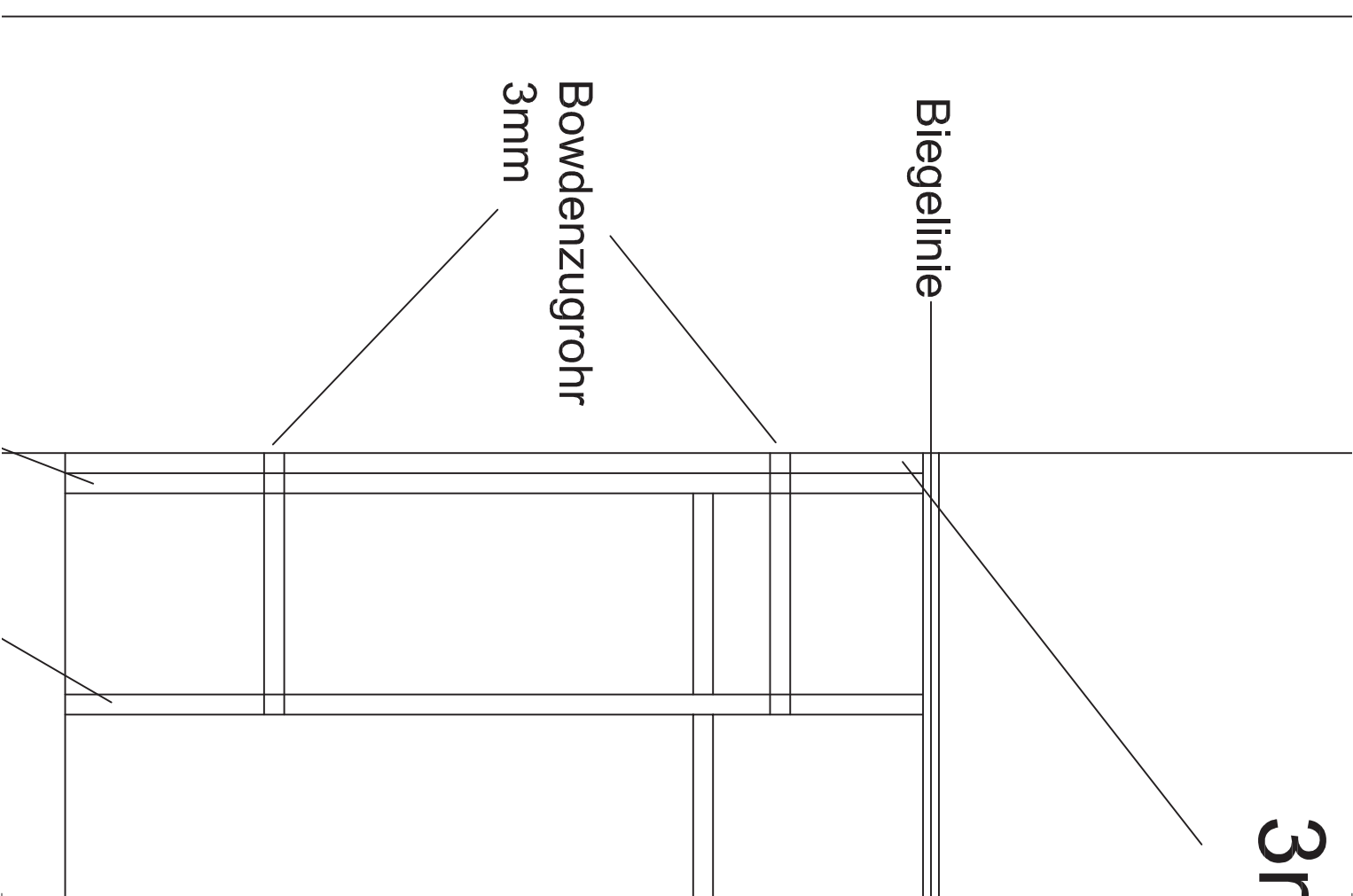

R1

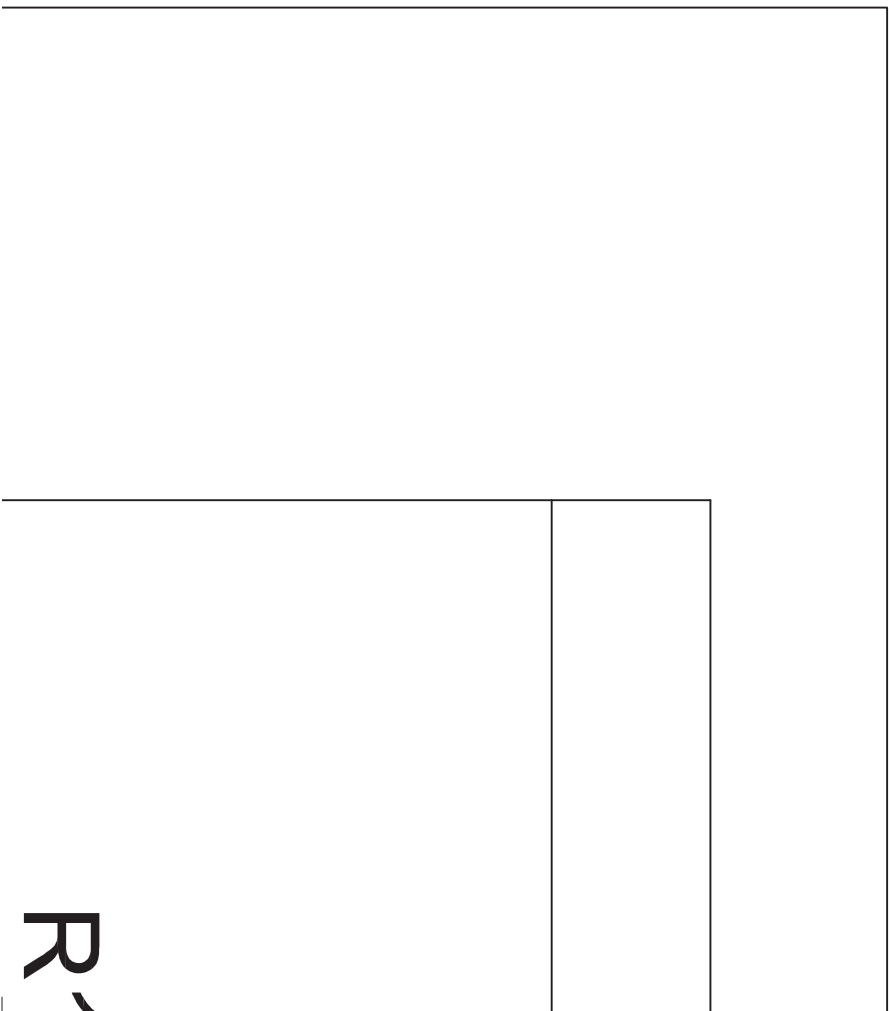

CFK-Stab 2mm

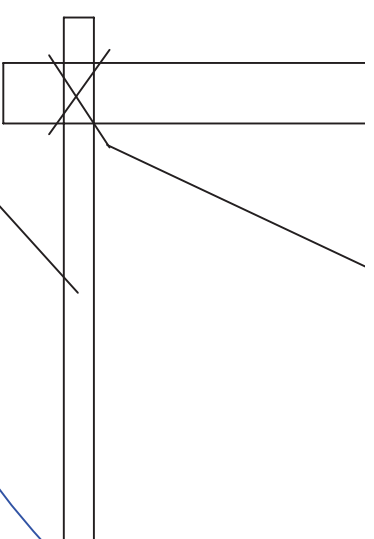

CFK-Rohr 3mm

CFK-Rohr 6mm

CFK-Rohr 4mm

hier mit Zwirn umwickeln

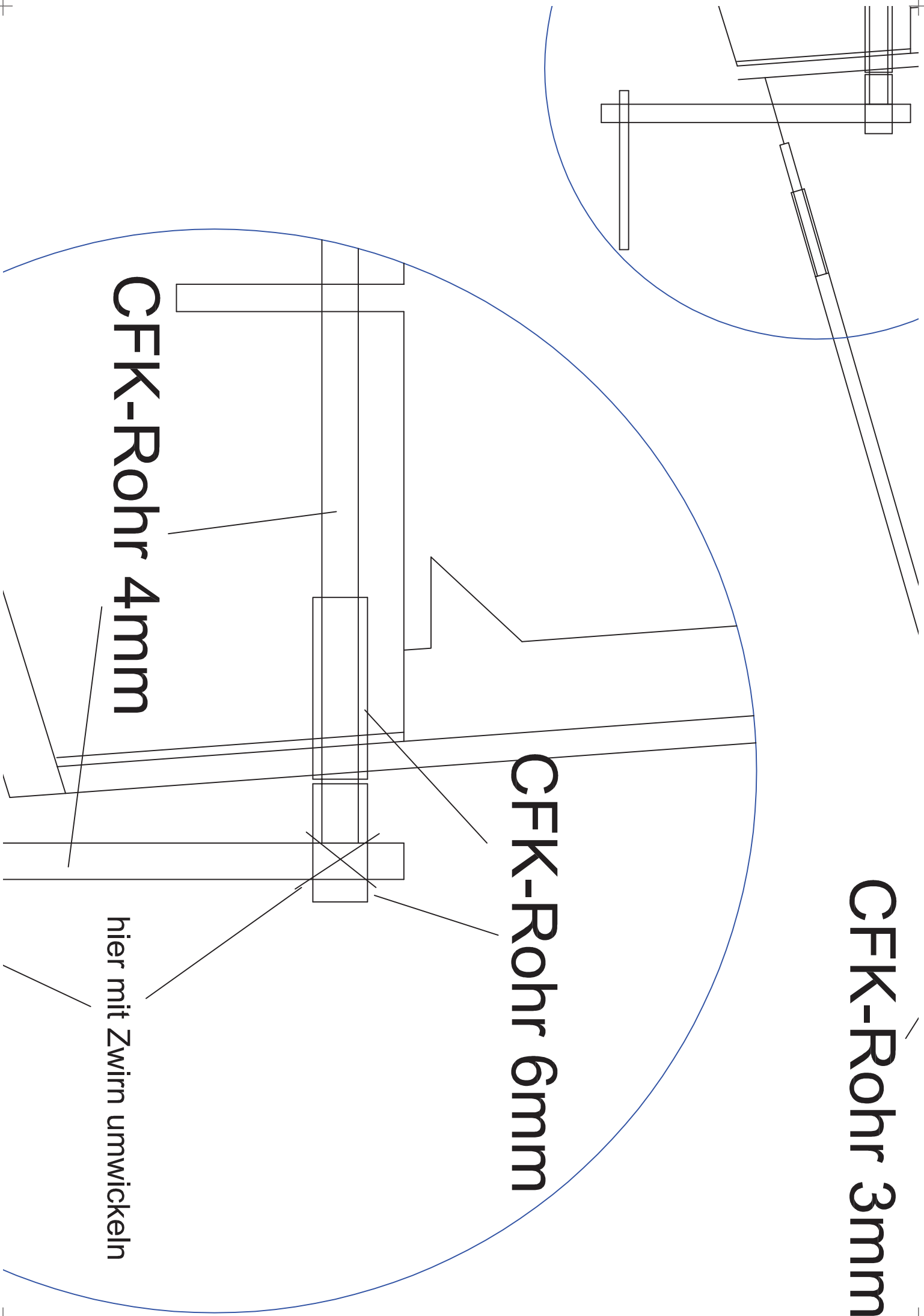

III1 a1sV111ayE11

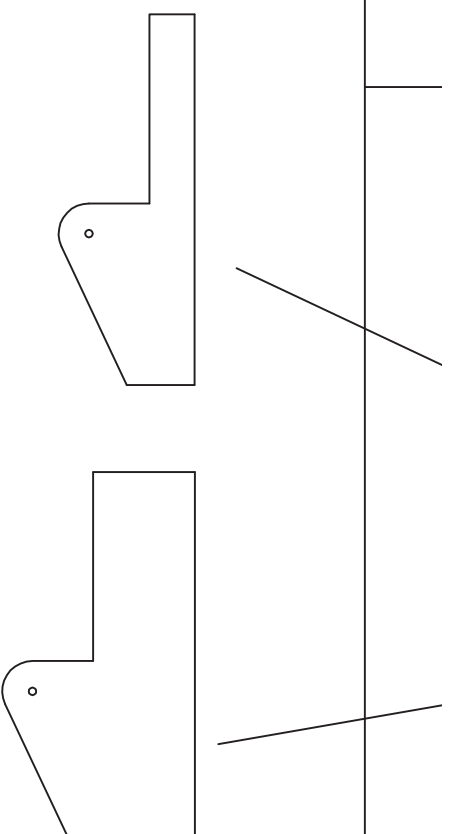

Sperrholz 1mm
2x

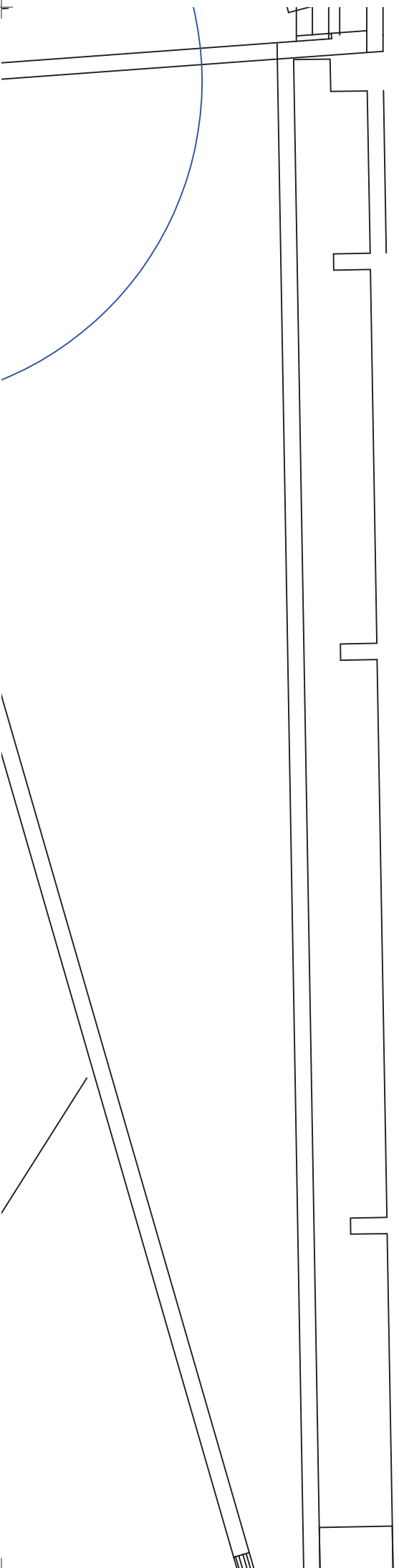

mm

hinnansökn

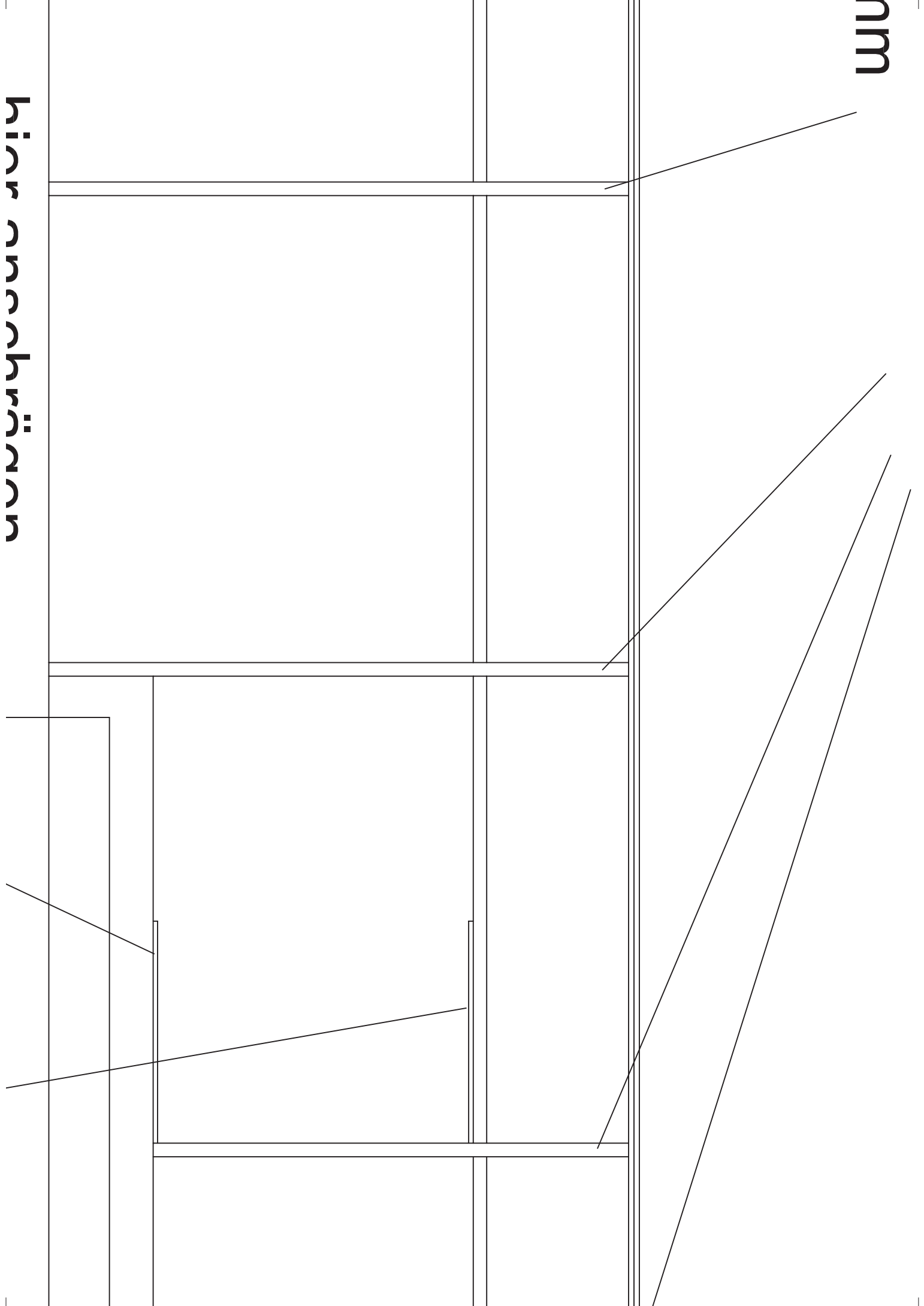

hier anschreiben

1, 4, 5, 6+7 Depron

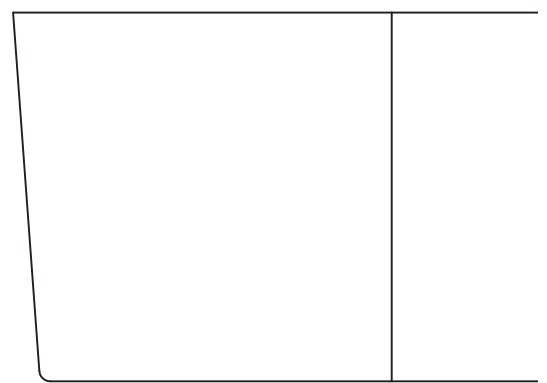
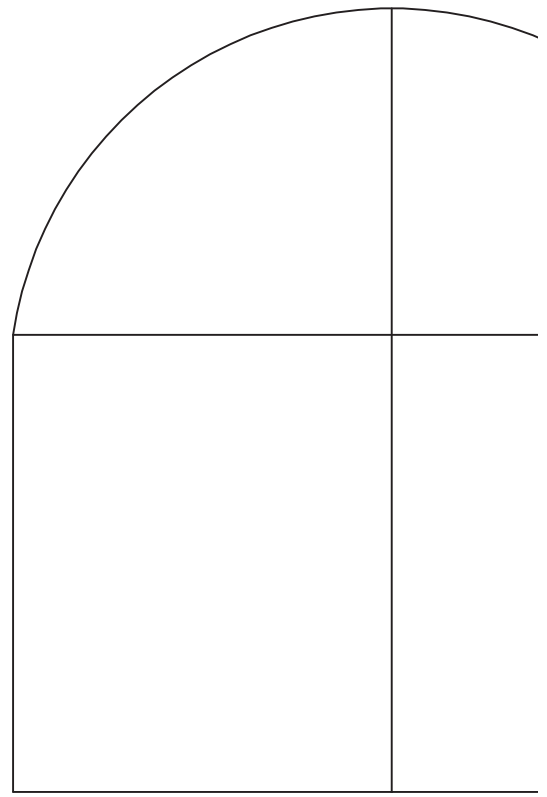

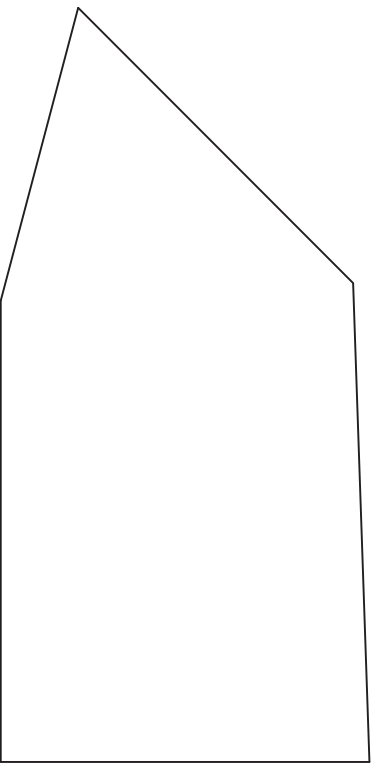
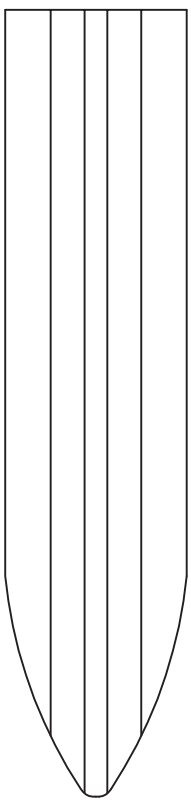
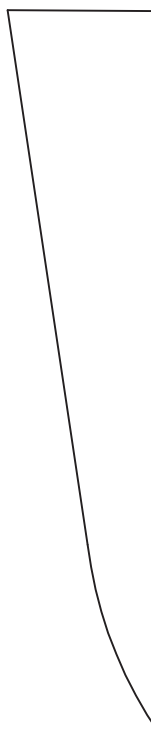

Schablonen zum erstellen einer Kabinenhaubenform

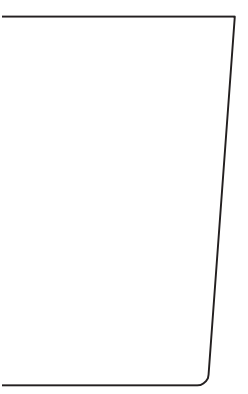
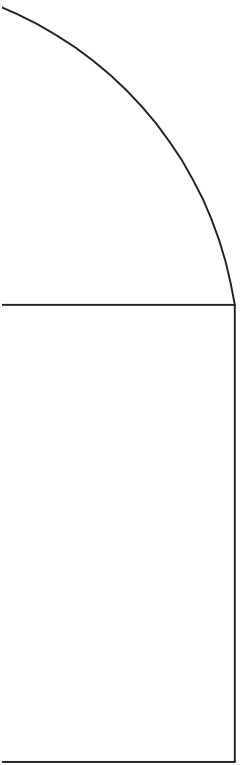

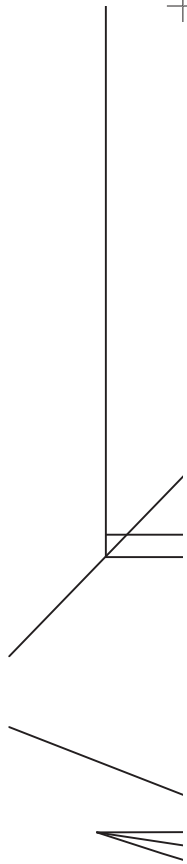

Keil Depron 6mm

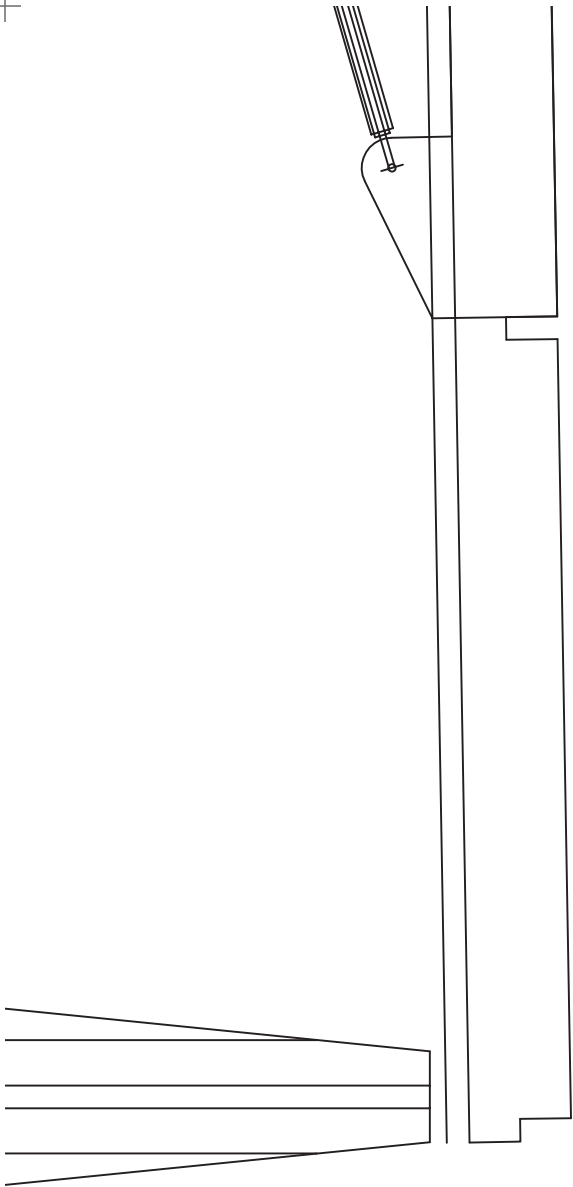
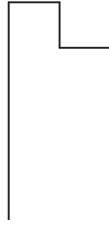

Stützwimmer



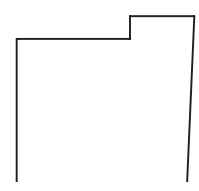
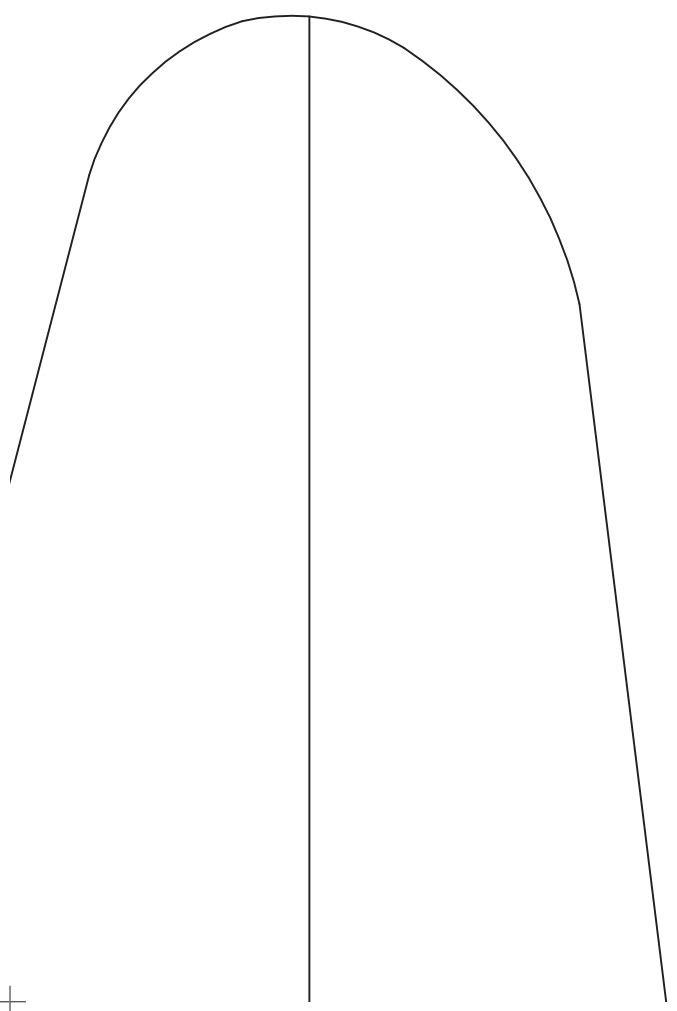
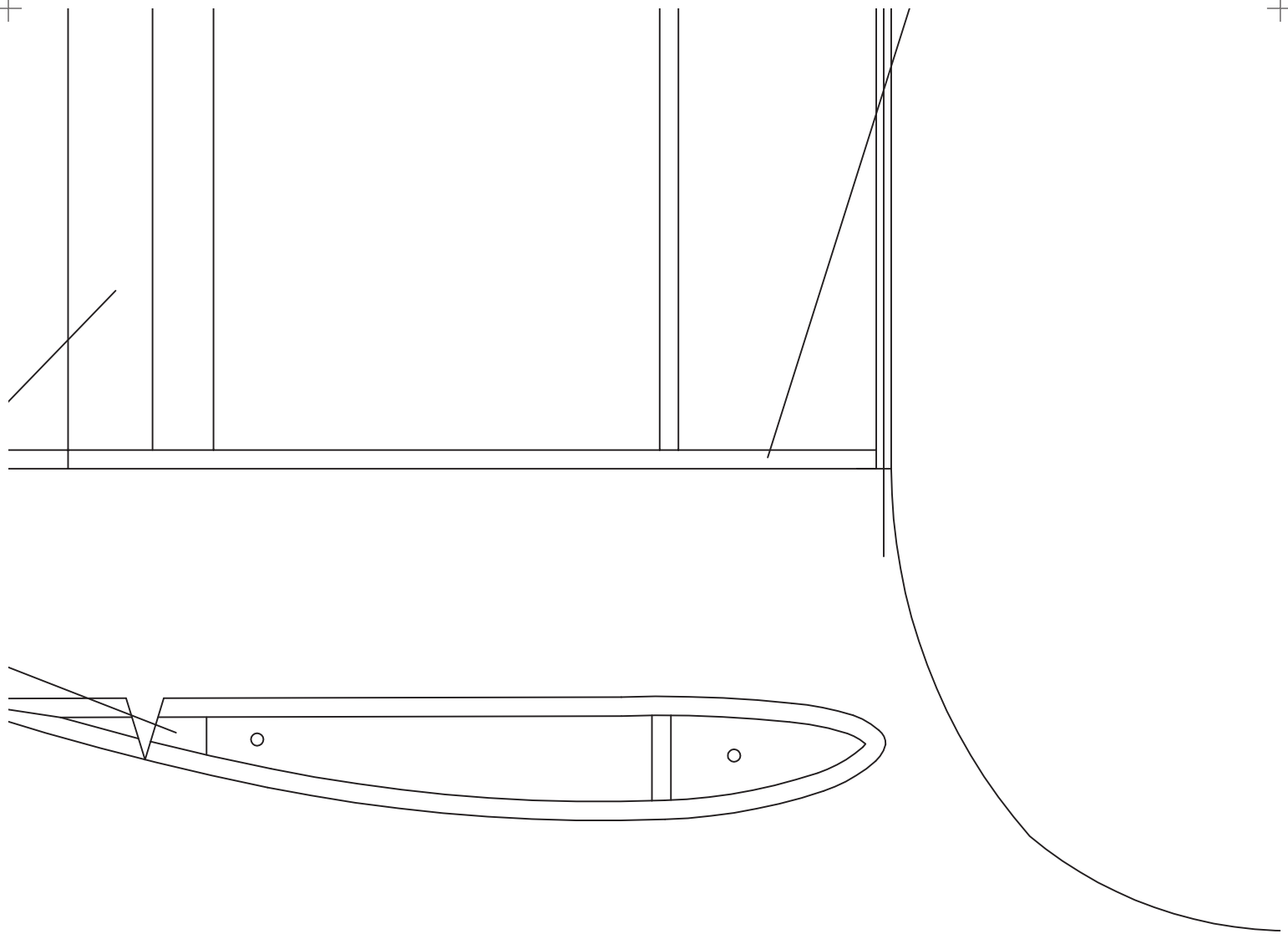

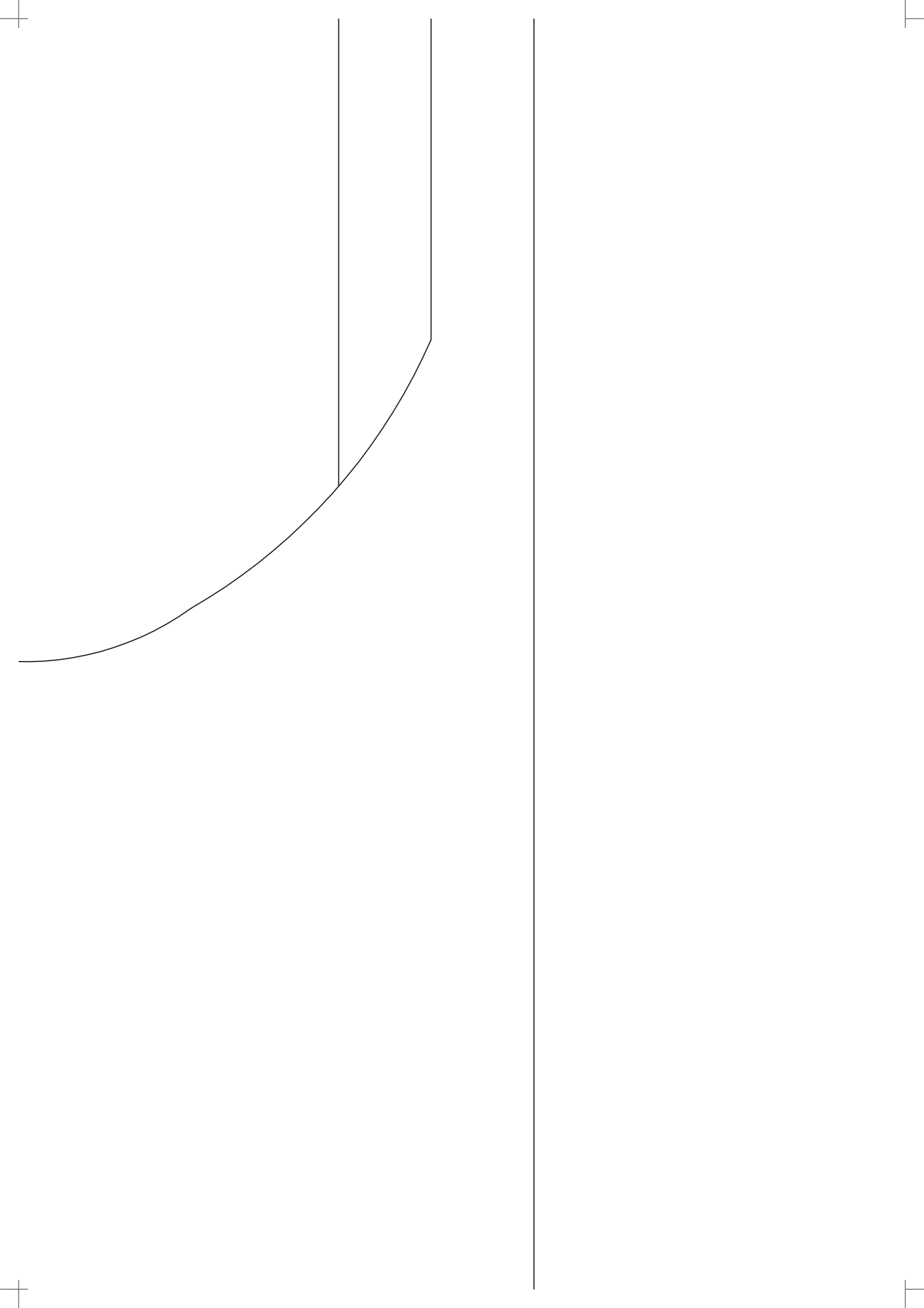

Konstruktion und Plan Jürgen Bestenle
Verwendung nur zu privaten Zwecken

Blatt 2/2

alle Teile Depron 3mm, wenn nicht anders

Scnabione motorpyion

Depron 3mm

Volmer VJ-22 "Sports" Amphibian

Semiscalmodell eines Amerikanischen "Homek

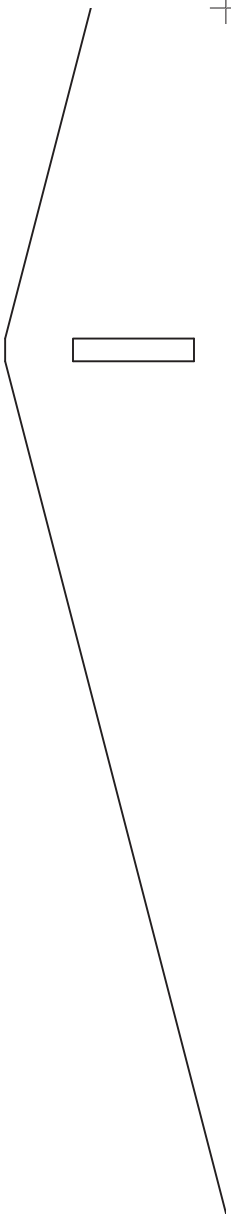

Holm Depron 3m

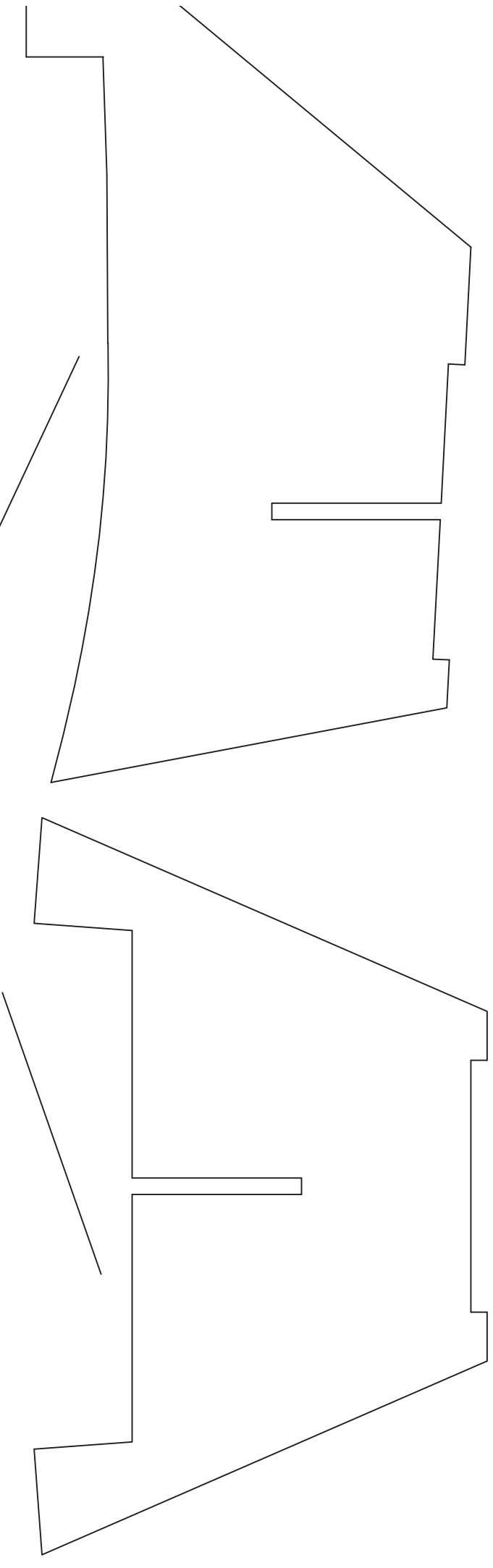
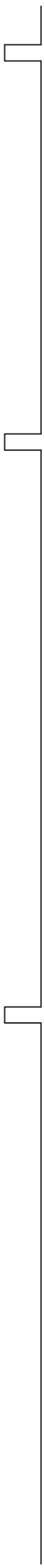

Copyright © 2014 by Holm Depron

4 x Bal

3mm



8,

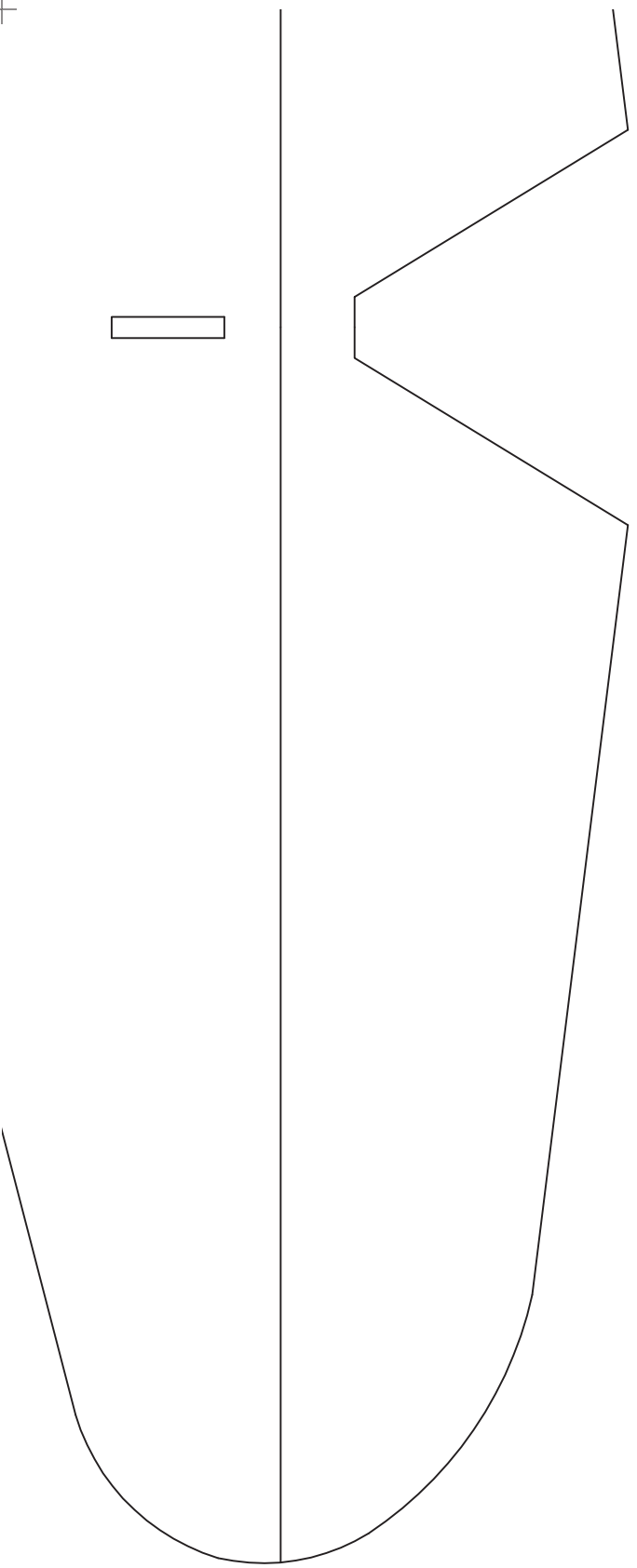

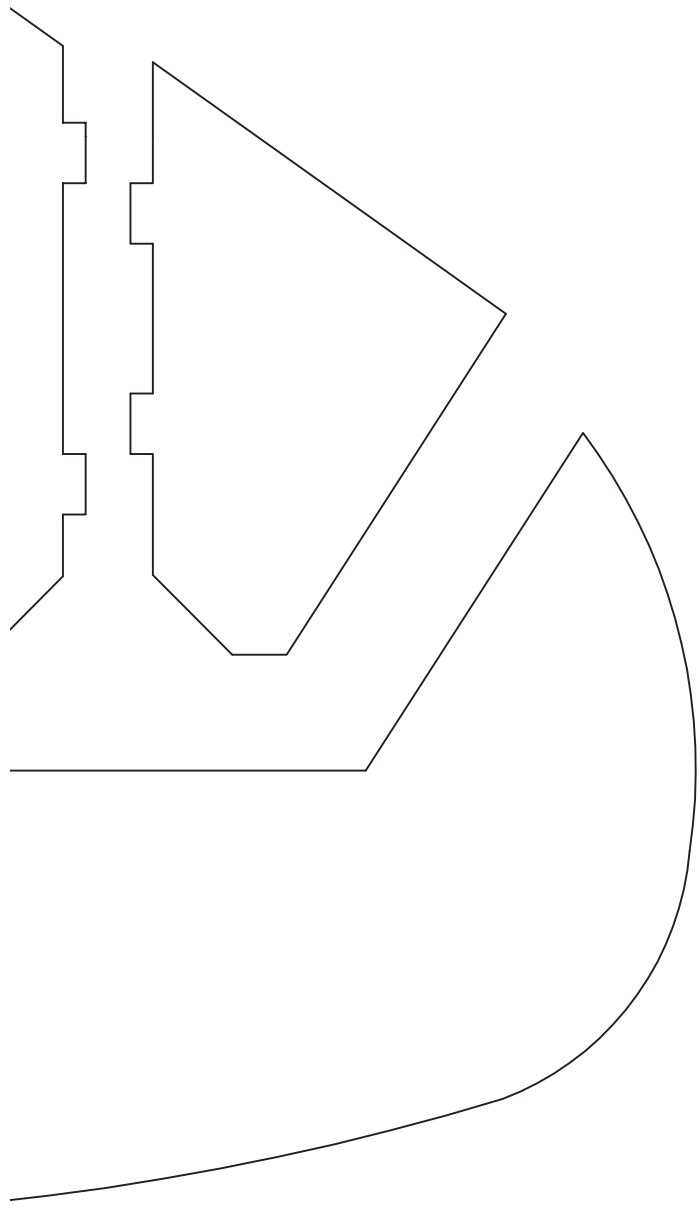

; angegeben



Papierschablone



man

quild™ M1:10

m



sa 3mm / 2x Depron



x Depron 3mm



