

Depro

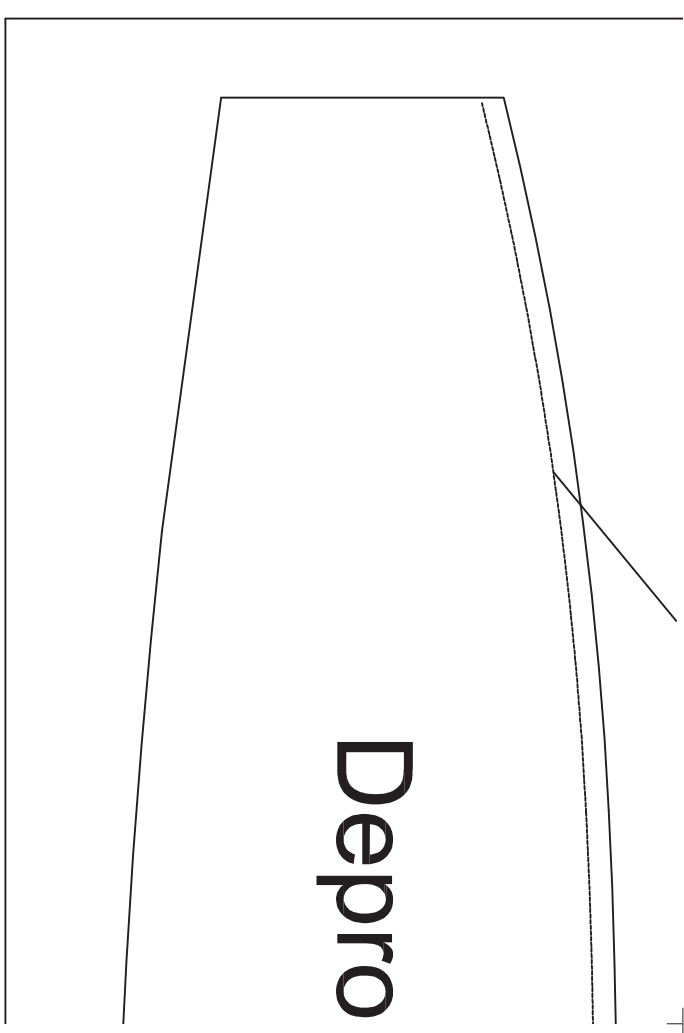

1. Rumpfboden

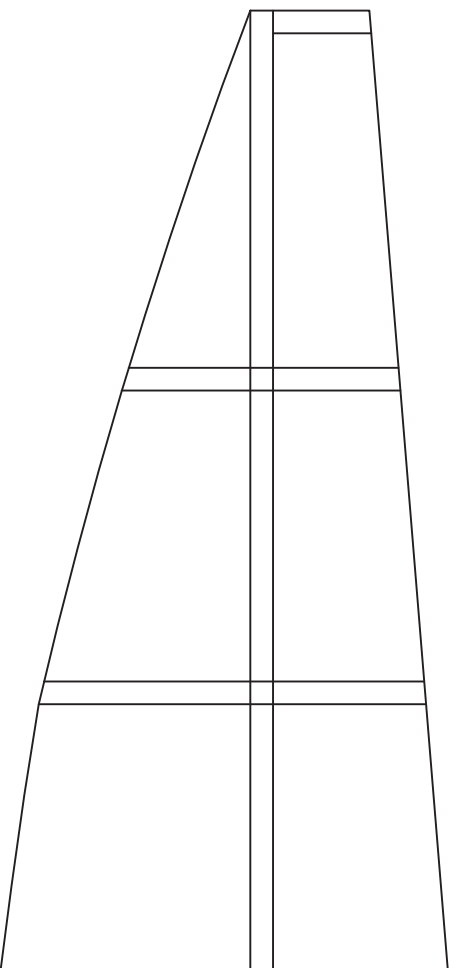

Deck

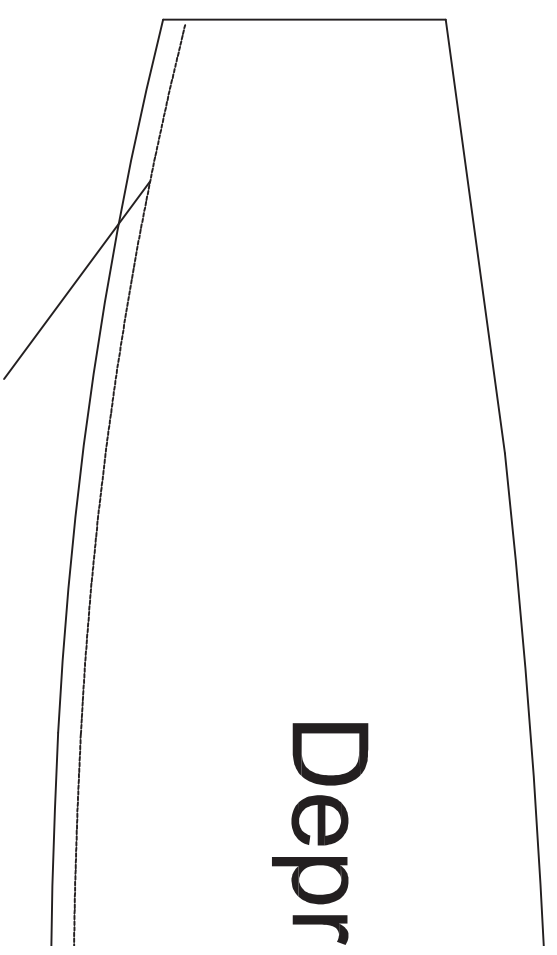

vorderer Rumpfboden

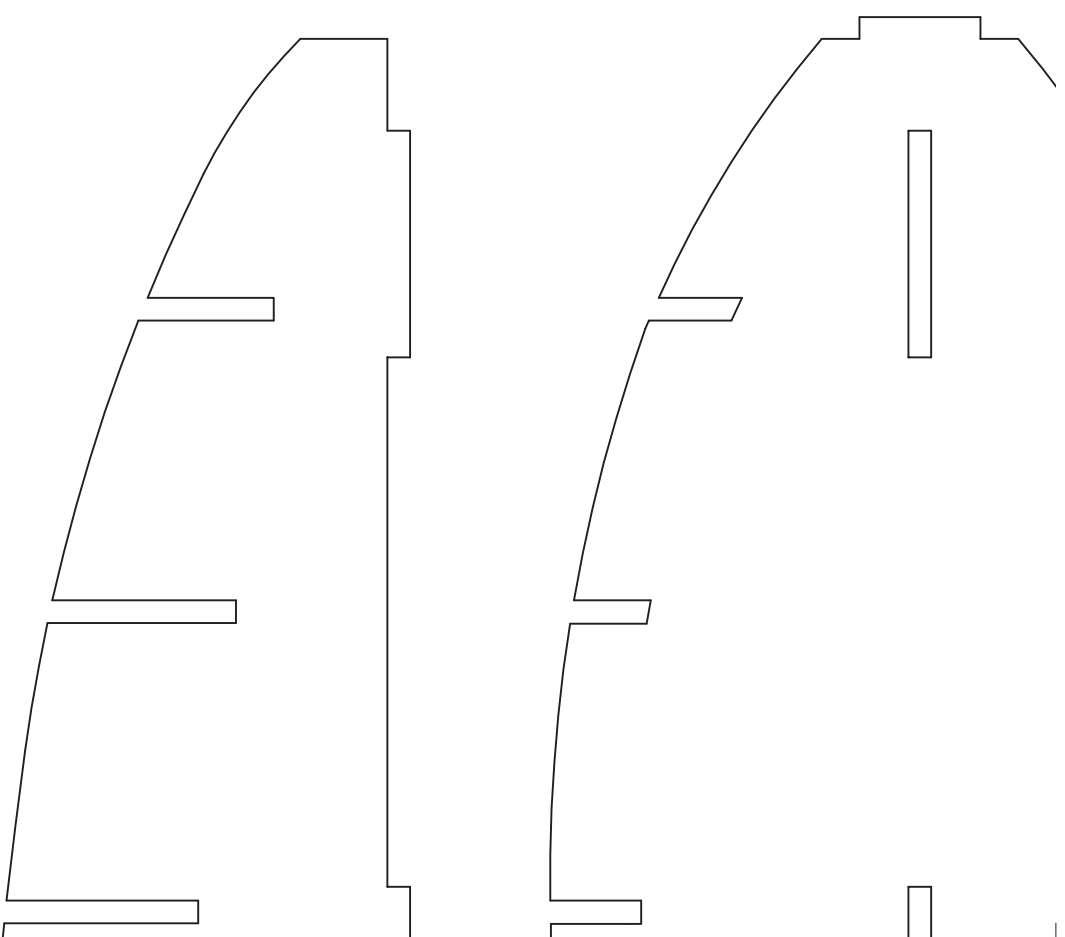

Rimnfaita 2

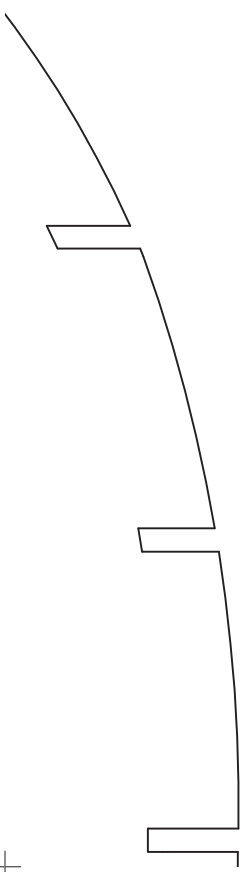
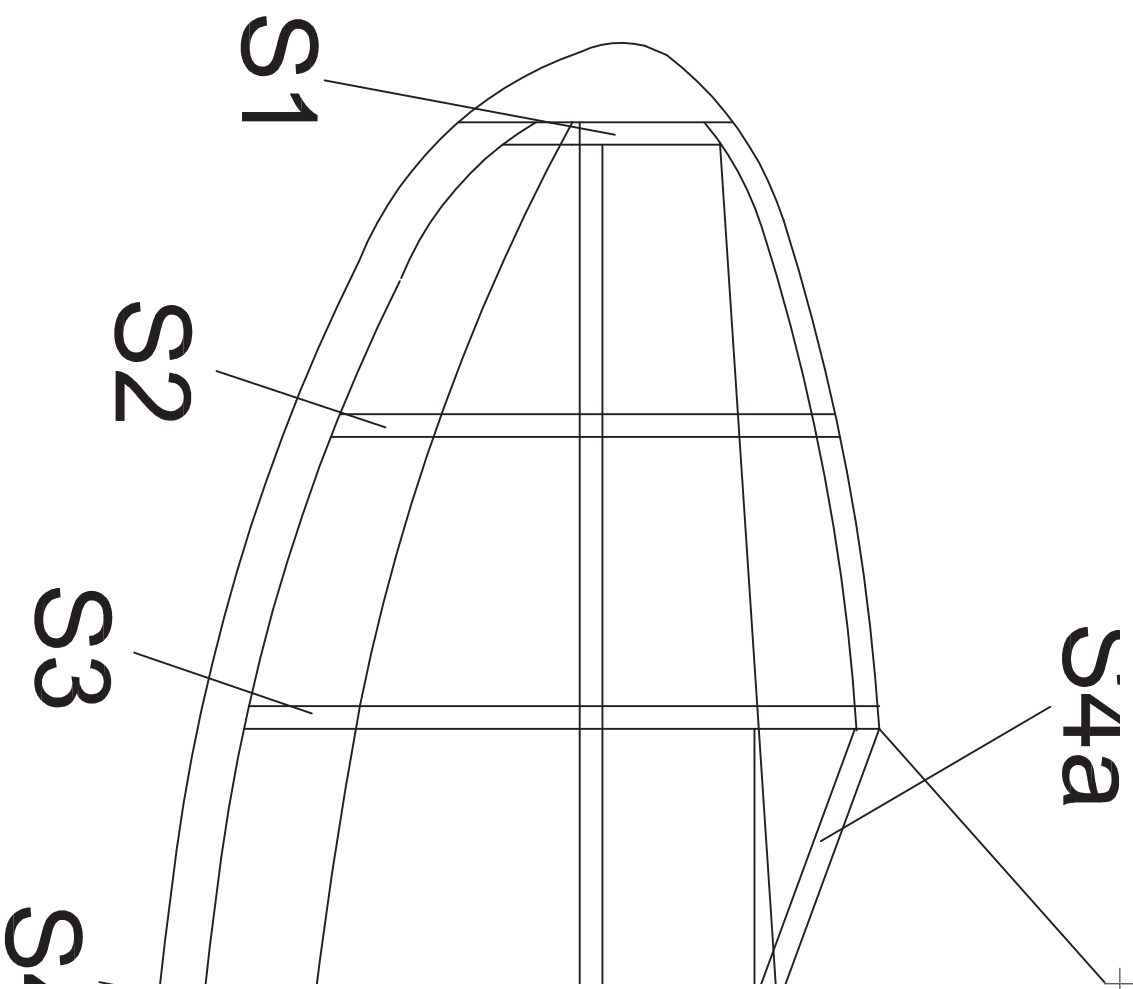

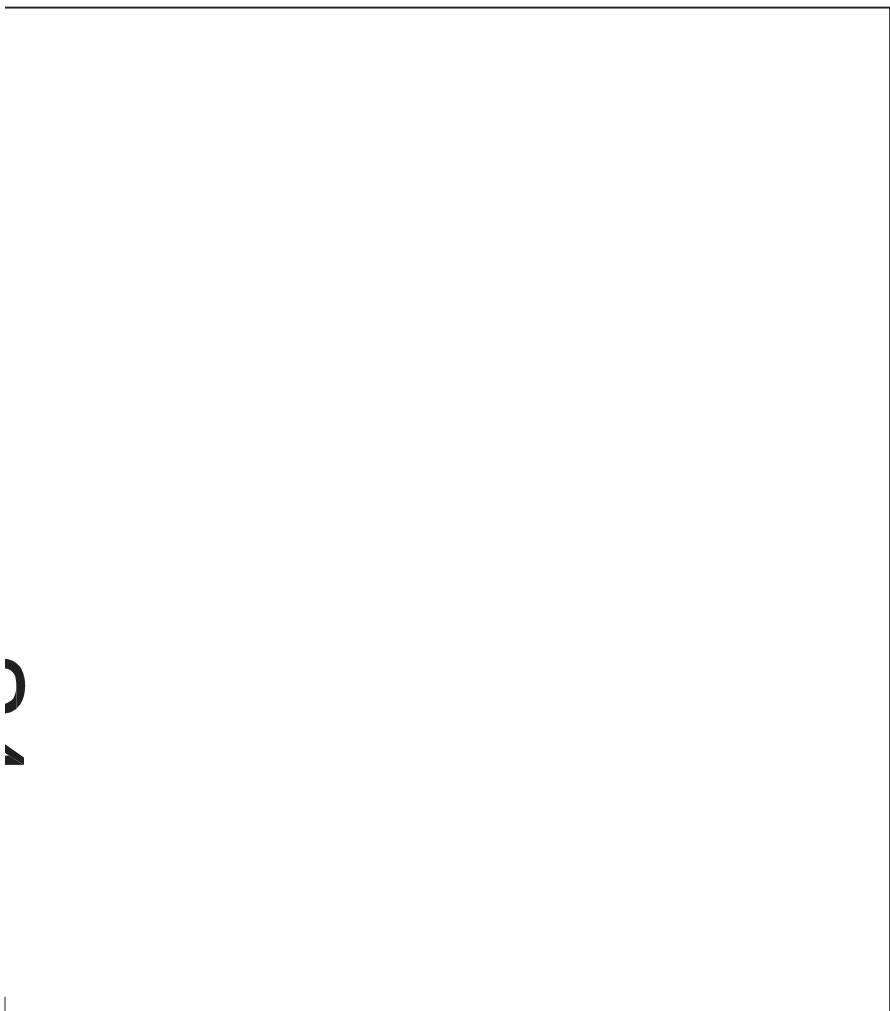

n 6mm

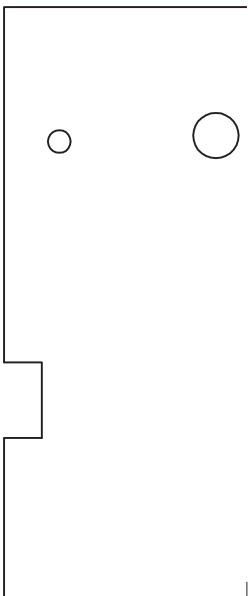
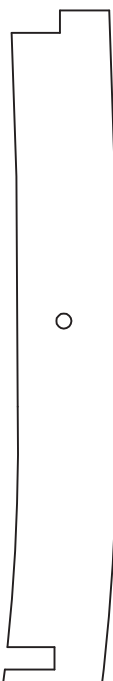
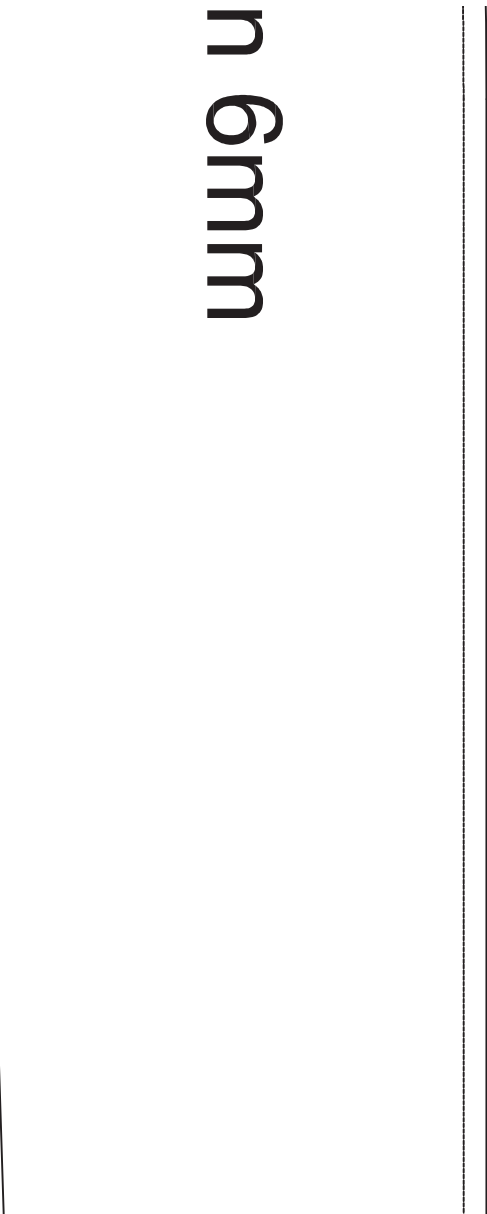

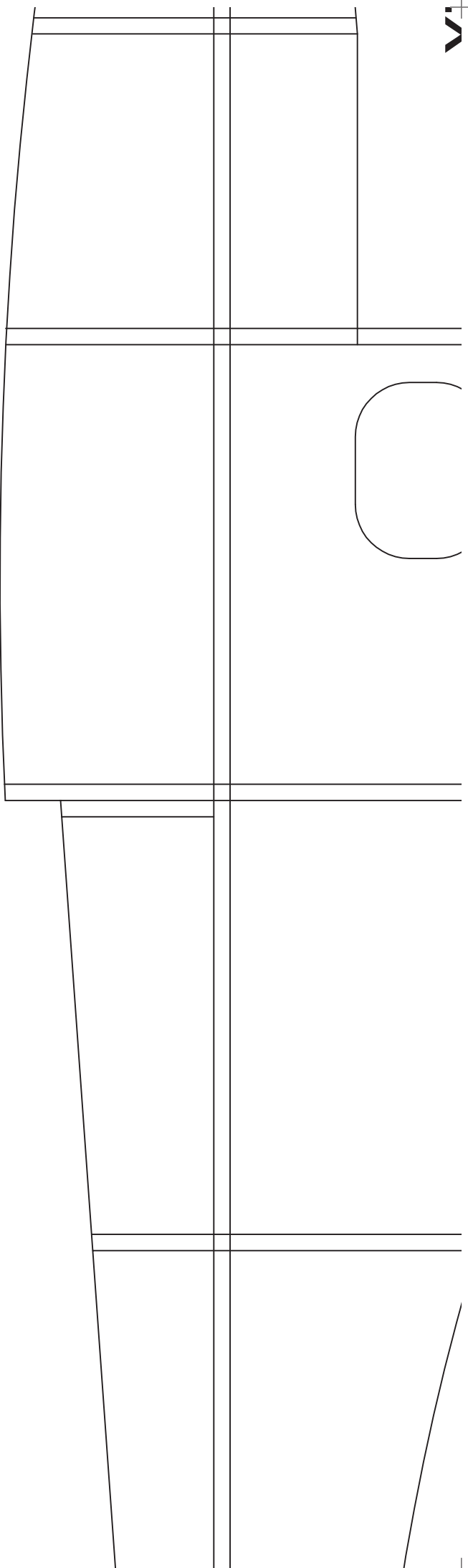

on 6mm

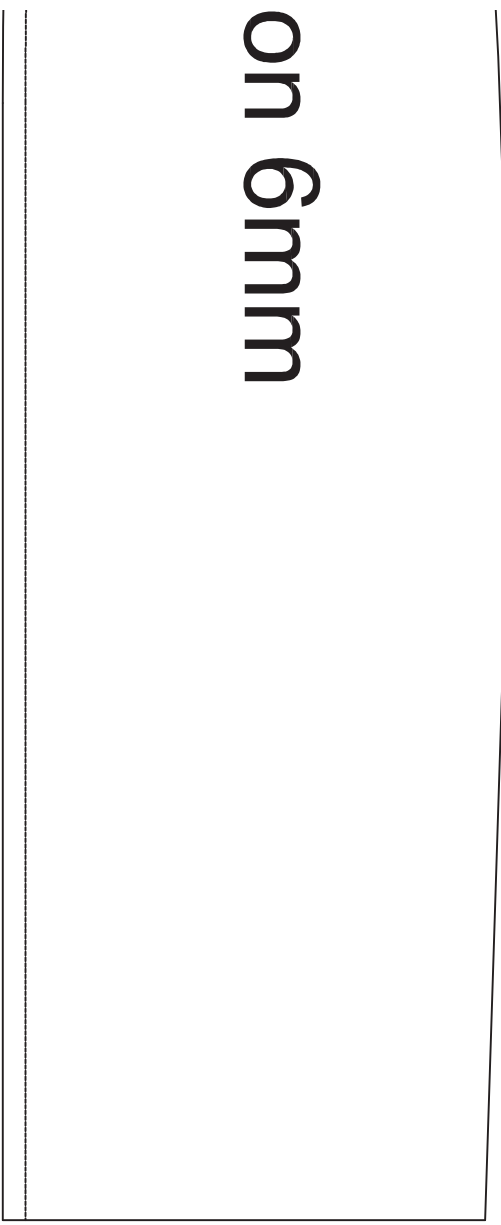

an an dieser Linie anschrägen

Sper Holz

2X

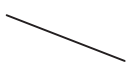

ZWISCHENBOUEN

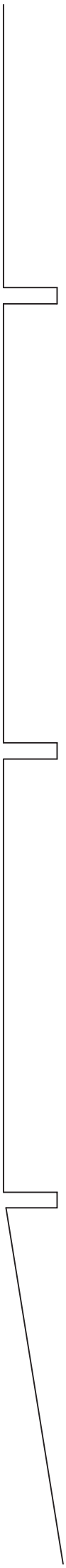

Kiel

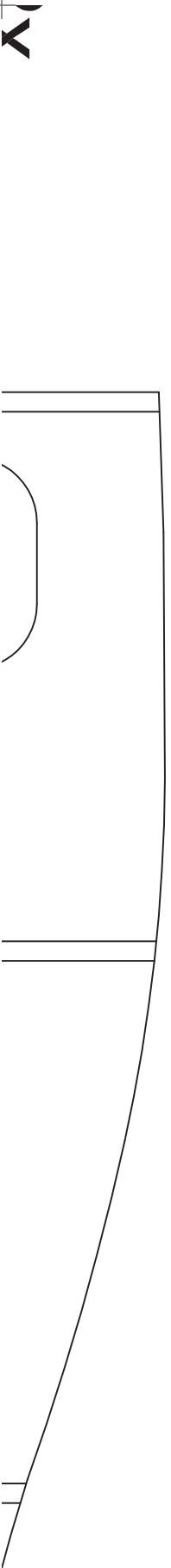
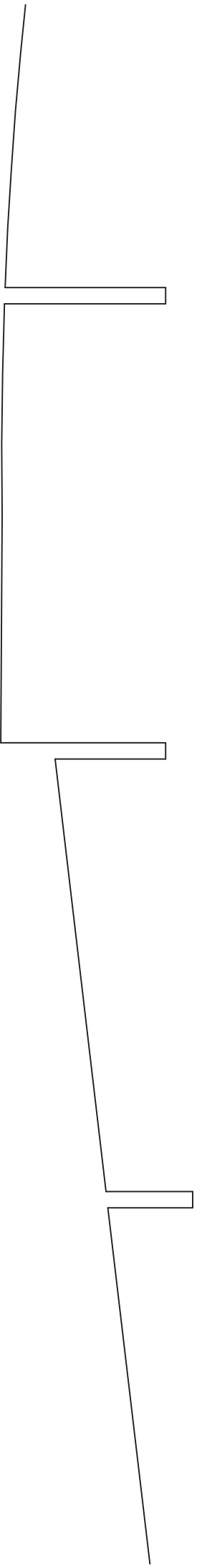

y

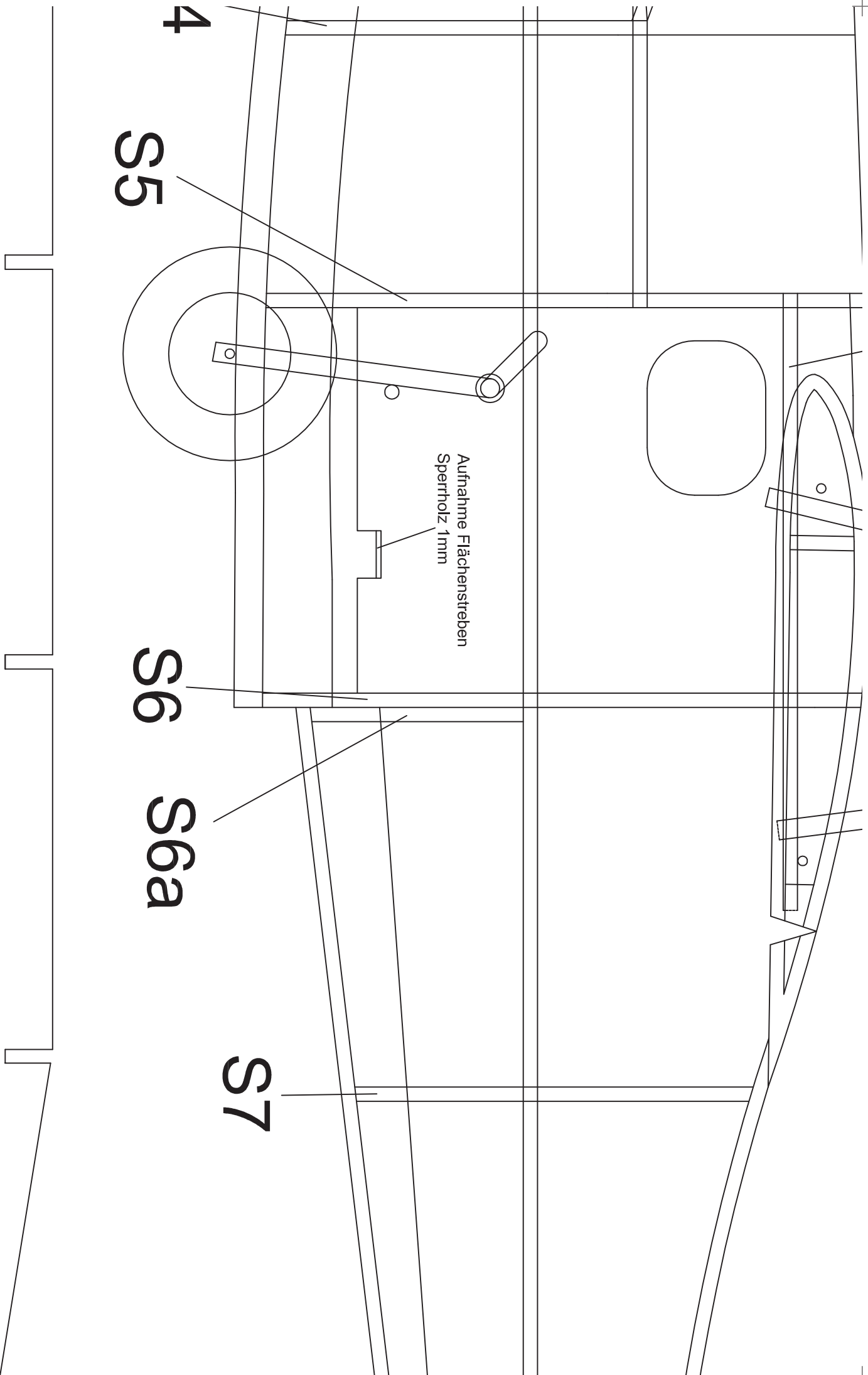

S4
S5

Aufnahme Flächenstreben
Sperrholz 1mm

S6
S6a

S7

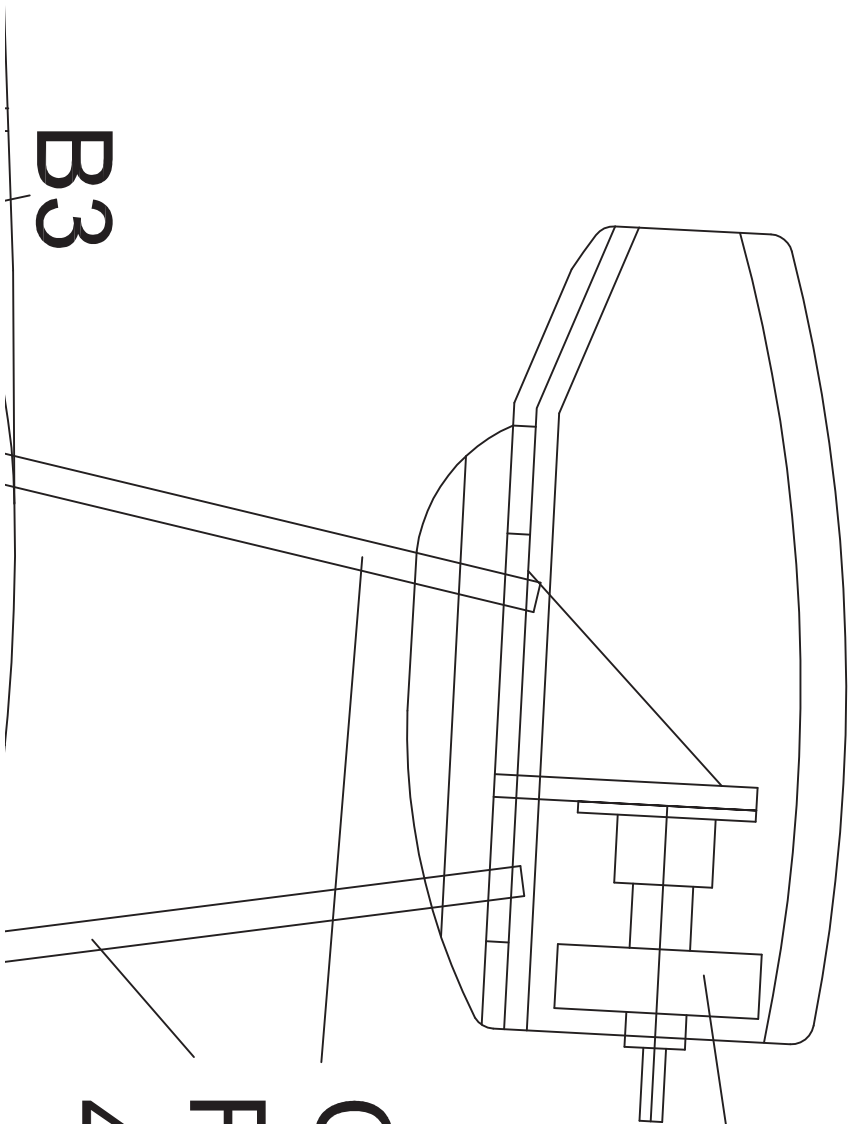

AL2730

CFEK

Rohr

4mm

B3

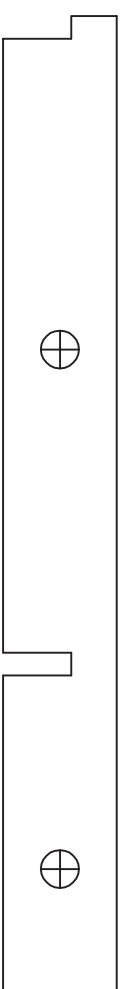

B3 - Balsa 3mm 2x

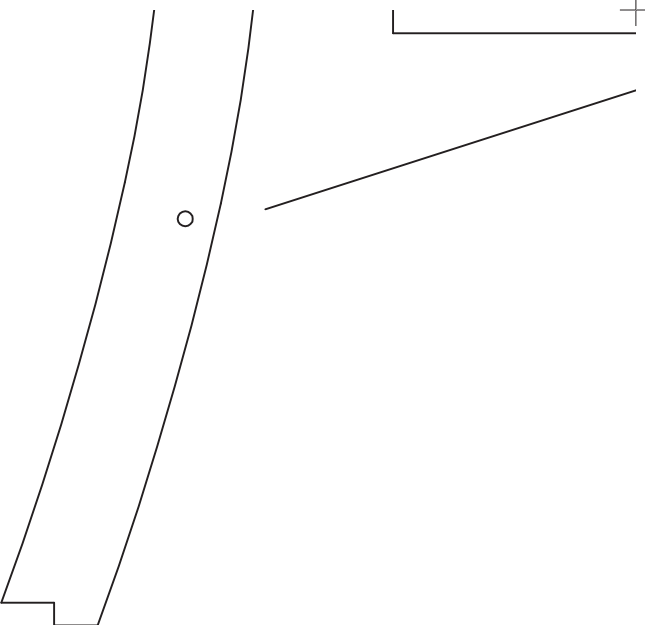

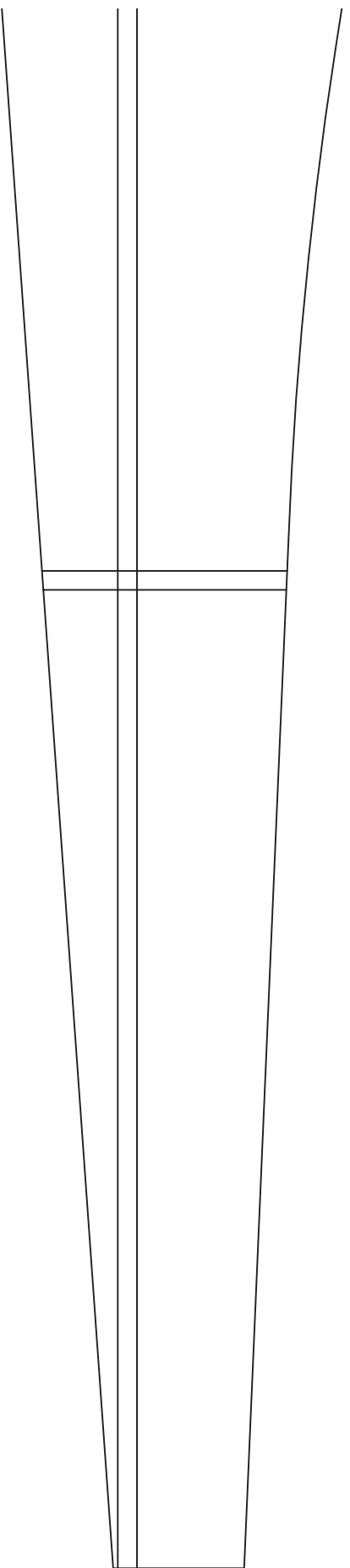

vordere Rumpfdecke
an der Strichlinie zum anpassen
anschrägen

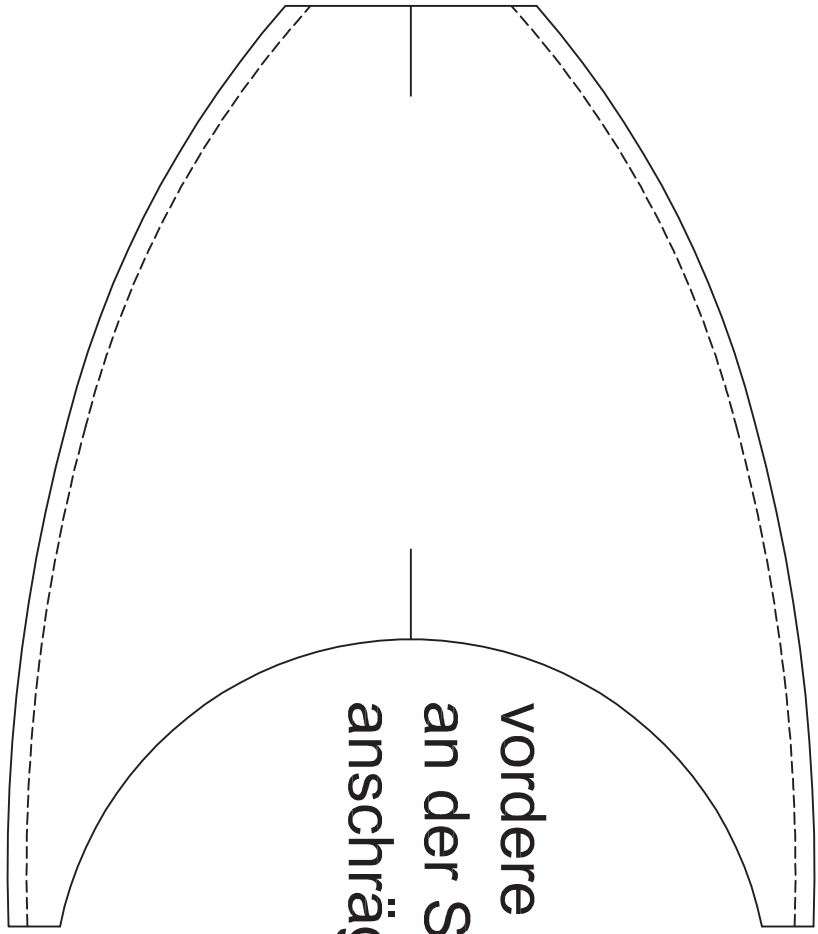

1mm

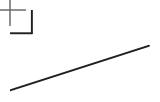

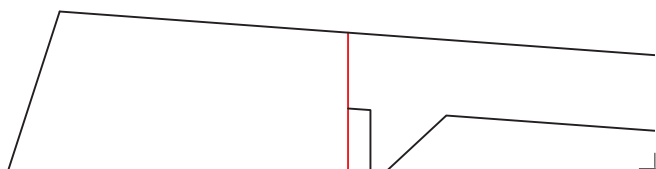
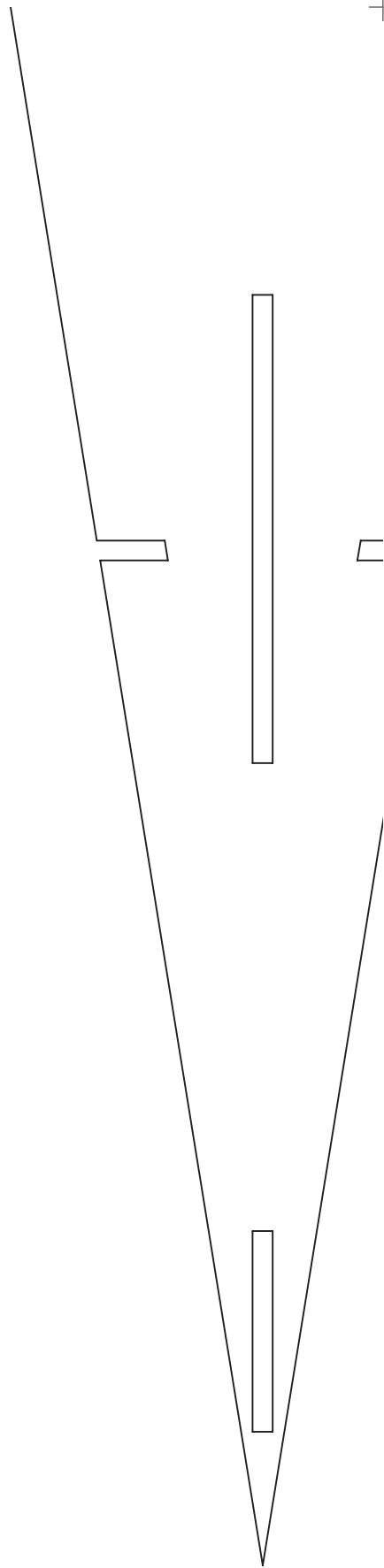
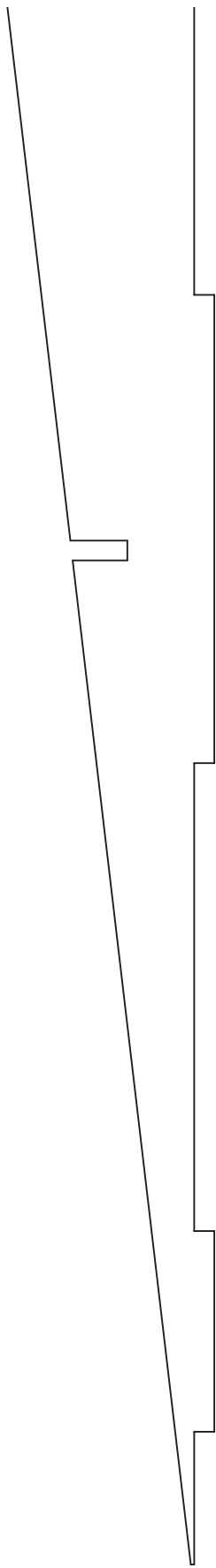

S8

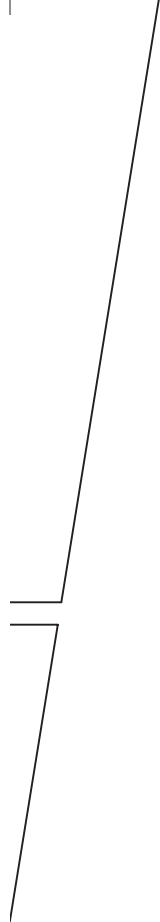
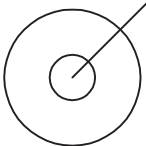
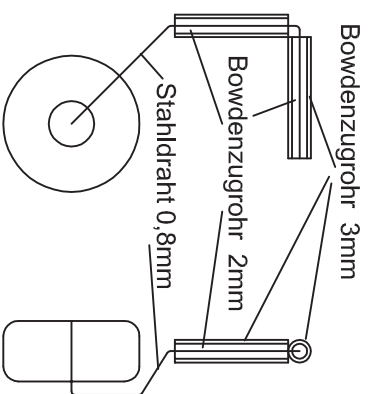

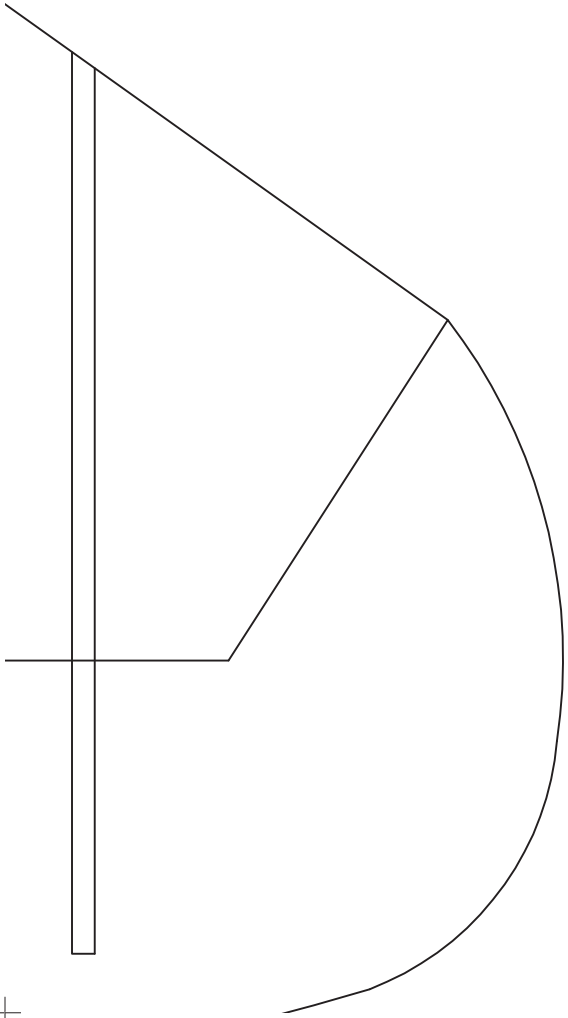

Semiscallemodell eines Amerikanischen "Hc
Konstruktion und Plan Jürgen Beste
Verwendung nur zu privaten Zwec

Blatt 1/2

alle Teile Depron 3mm, wenn nicht ande

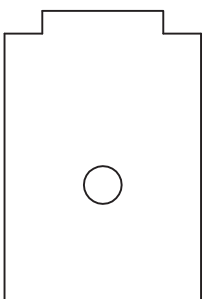
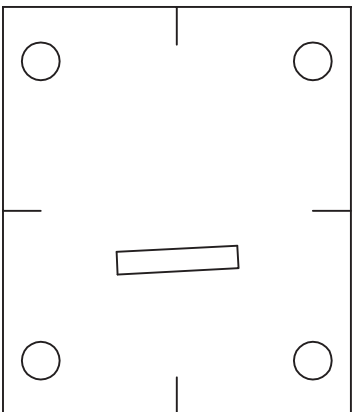

Sperrholz 3mm

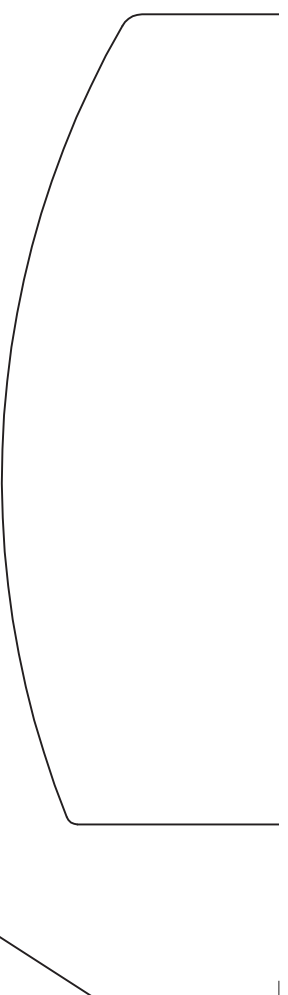

Depron 6

Volmer VJ-22 "Sport" Amphibiban

S6

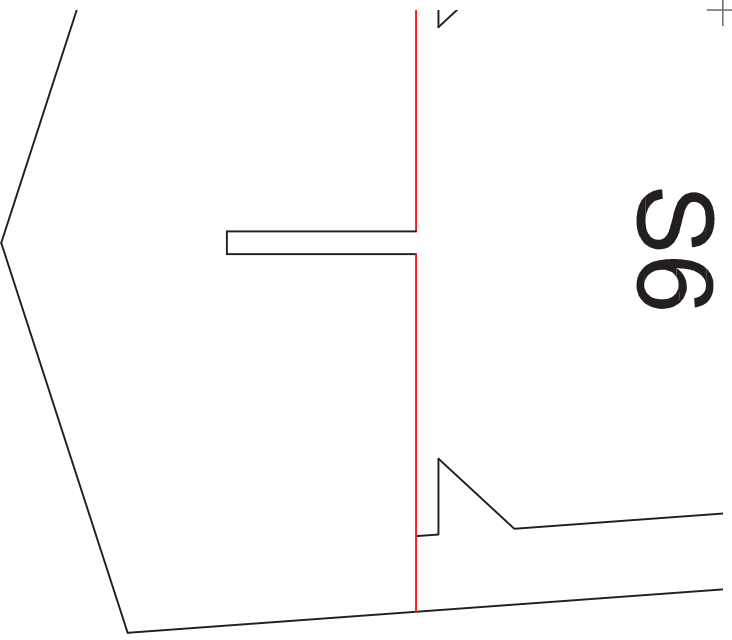

S6a

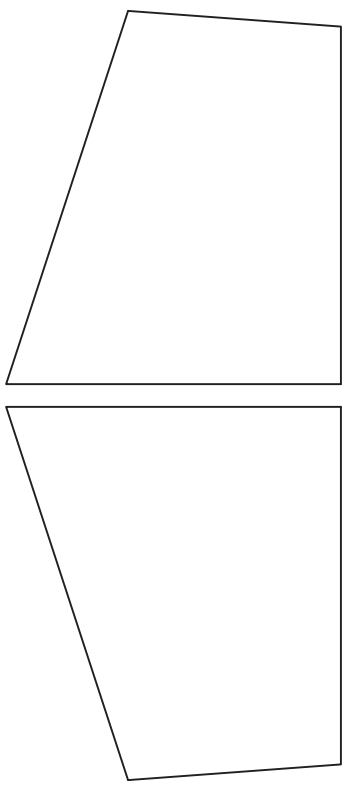

S7

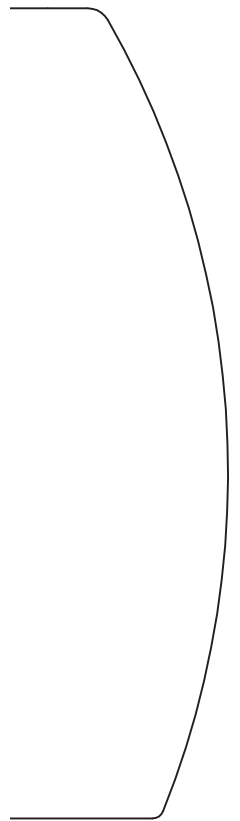
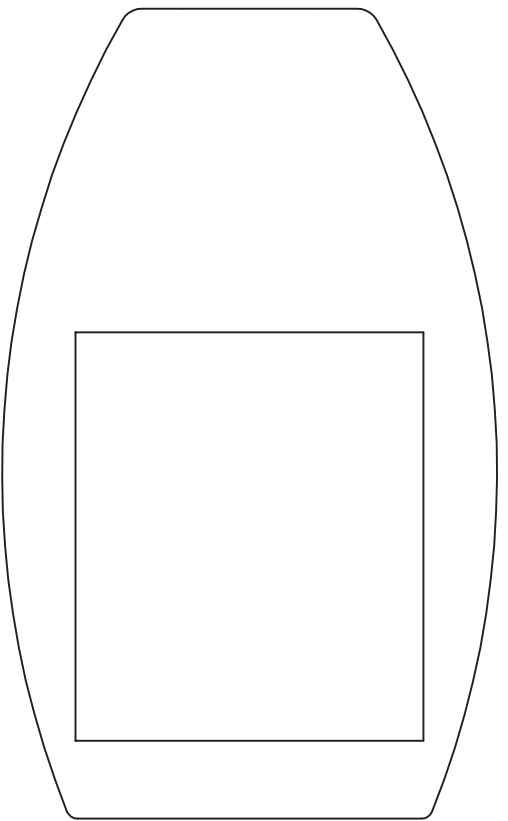
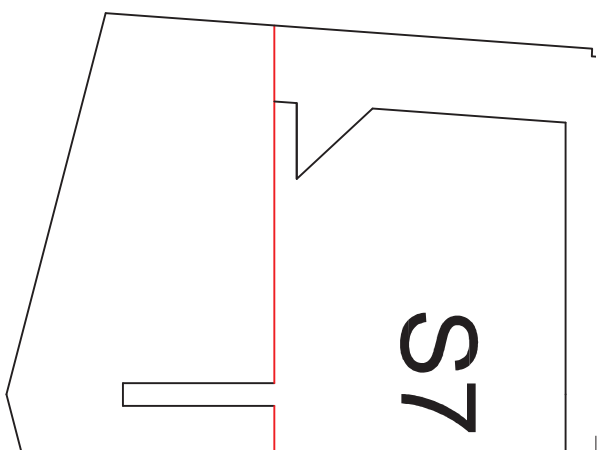

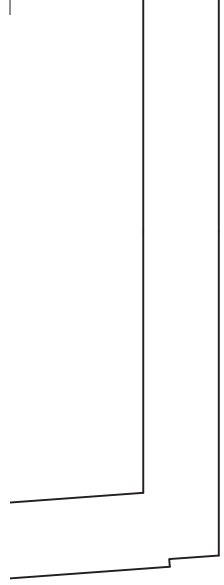
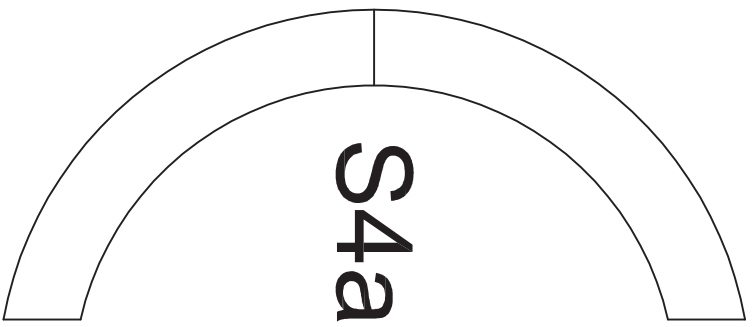
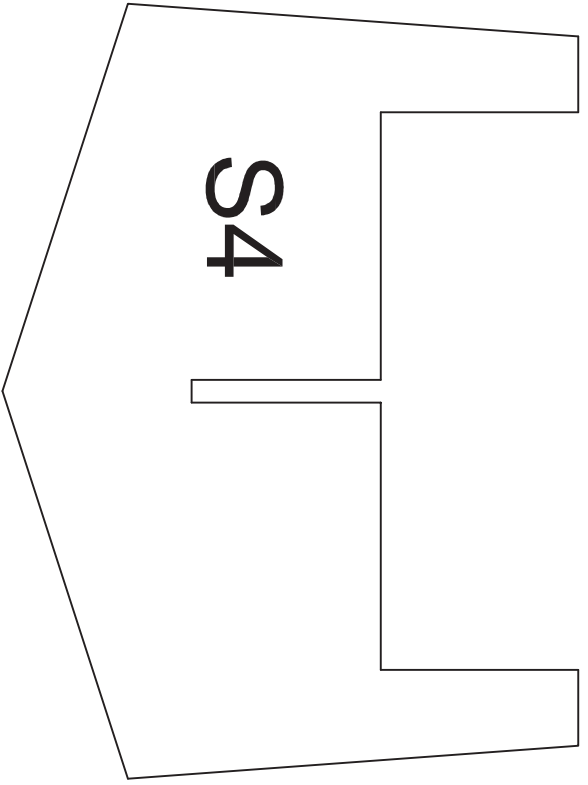

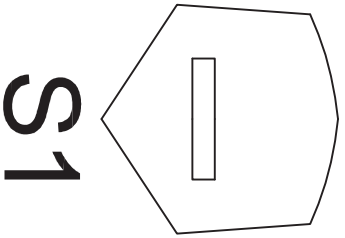

S1

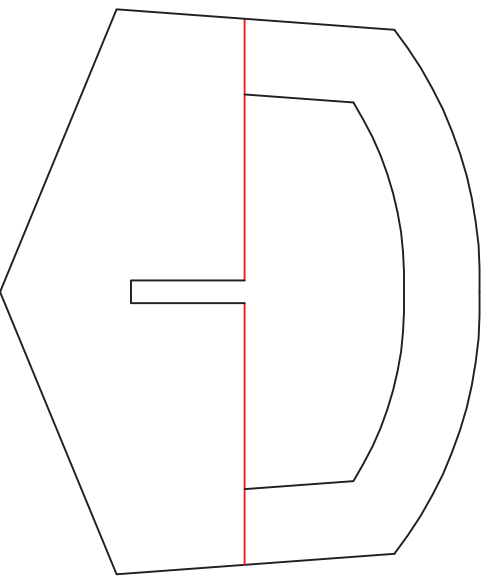

S2

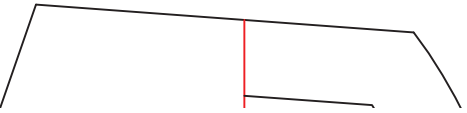

„mebuid“ M1:10
„lehner
„ken

ars angegeben

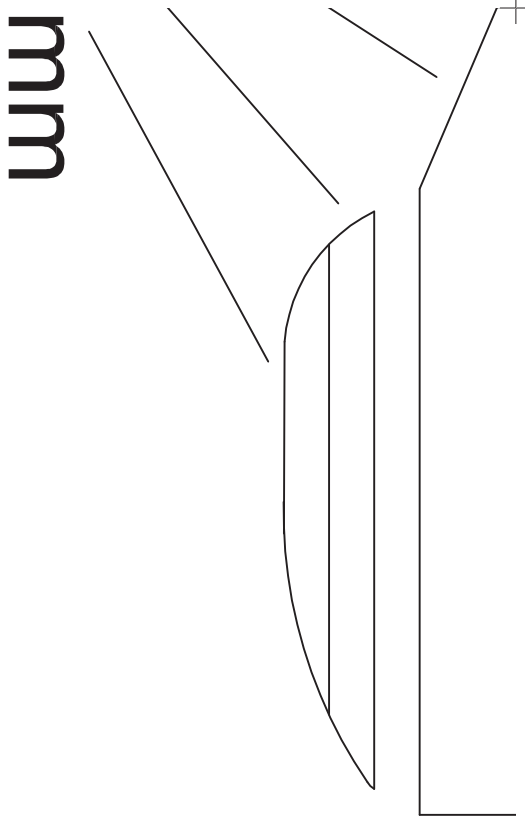

tsman™

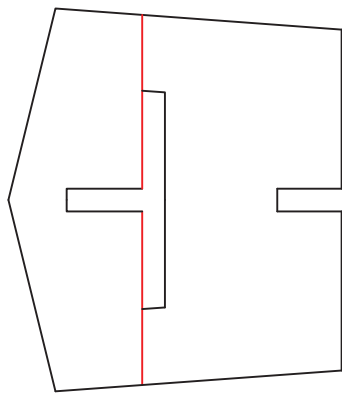
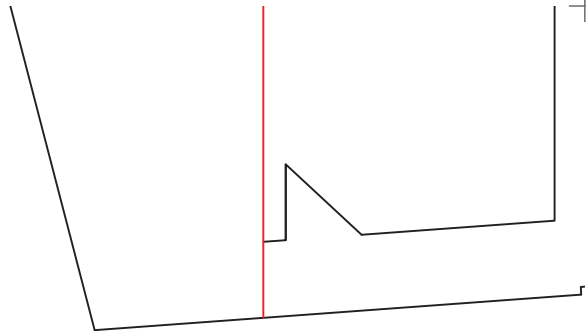
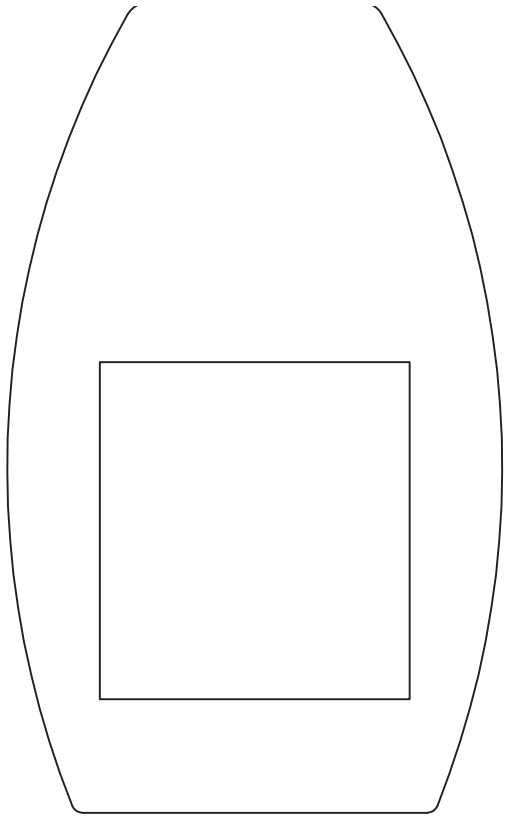
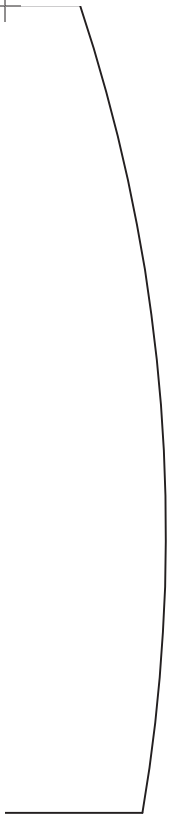

88

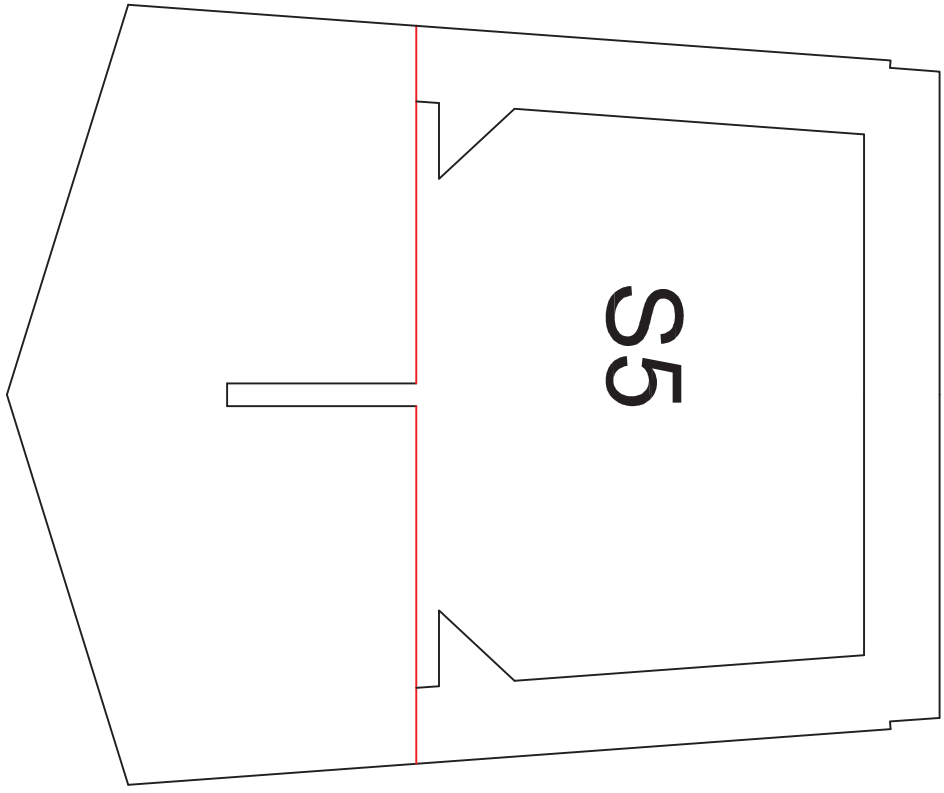

S5



